



SHADING SOLUTIONS BY DESIGN



Zip[®] 85, 110 & 150 gravity drop systems



85, 110 & 150 gravity drop systems

OVERVIEW

- ZIP® technology to enable smooth operation
- Used for areas up to 50m²
- Features headboxes and side channels

SYSTEM DETAILS

SHY ZIP® gravity drop blinds operate vertically and can be custom-made to fit any angle from vertical to 30° from the vertical. (For blinds over 30° from the vertical, please see our ZIP® CTS rooflight system).

The heart of the system is SHY's specially designed zipper ribbon which is welded to the edges of the blind fabric to create a super-strong, flat join. The zipper ribbon is securely held in a shaped plastic side channel which allows the blind to run freely and quietly but prevents the fabric from being pulled out of the channel insert.

A ZIP® gravity drop blind consists of an upper headbox containing the cloth roller plus side channels. As the cloth is deployed the combined weight of the cloth and hem bar pulls the cloth down the side channels. No lower headbox is required, but a bottom channel can be used to enhance the light seal or to help with uneven surfaces if required.

APPLICATION

Ideal for both commercial installations as well as high-end domestic situations. Neat and stylish, ZIP® gravity blinds can be installed in multiple applications including dim-out, shading, light control, heat control, insect screens, room dividers, for business presentation & home cinema screens, to name a few. Utilising a wide choice of blind fabrics, every level of shading, through to full dim-out can be achieved.

Hardware can be powder coated to any RAL colour (standard colours are white and black) to suit existing surroundings. Obstacle detection motors are also an option if required.





Features



SIDE CHANNELS

- 33x28mm side channels
- Flange mounted or through mounted
- Zipper ribbon runs within the inner rail



HEADBOXES

- Standard headbox sizes are 85mm, 110mm and 150mm square
- The choice of box depends on the size of the blind, with larger blinds requiring larger headboxes
- A 65mm headbox is also available for smaller systems. (Please see separate 65 ZIP® literature)

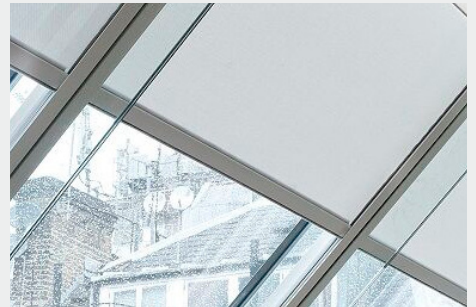

FABRIC

- Blackout – prevents or significantly reduces the amount of light passing through the fabric
- Glass fibre and polyester screen – protect against heat and glare of the sun



MANUAL CONTROL

- Chain (size dependent)
- Crank handle (size dependent)
- Hand (size dependent)



MOTORISED CONTROL

- Radio control – remote or switch
- Hard wired – switch or integration into control systems
- Battery powered (up to 7m²)



BOTTOM CHANNEL

- Optional on gravity blinds and is used to enhance the light seal or to help with uneven surfaces



System Specification

HEADBOX DIMENSIONS



Gravity drop blind

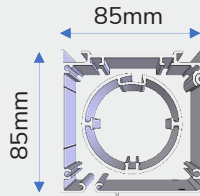

85mm headbox with Ø60mm tube

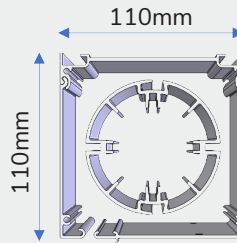

110mm headbox with Ø80mm tube

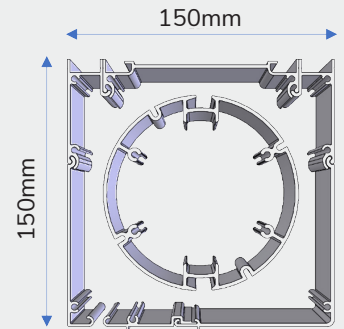

150mm headbox with Ø110mm tube

ZIP® SIDE CHANNEL DIMENSIONS

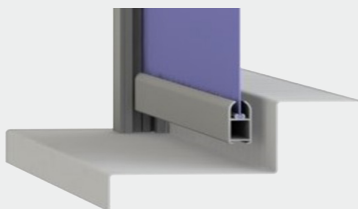
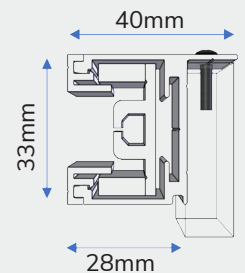
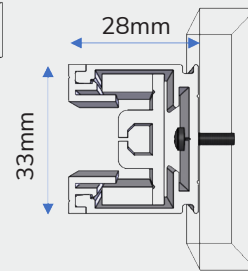
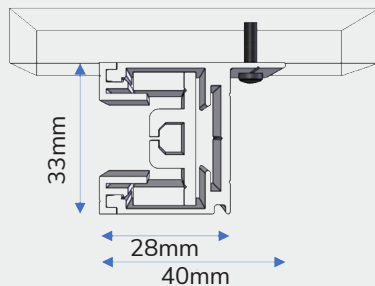

Gravity drop blind without bottom channel

HEMBARS

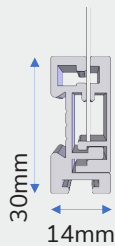

30mm Hembar (85 hand blinds only)

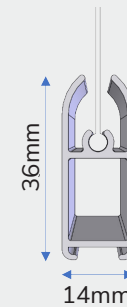

36mm Hembar

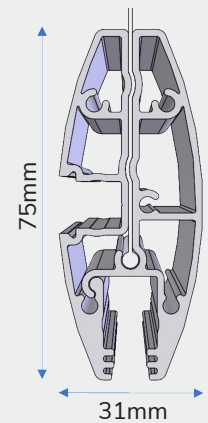

75mm Hembar

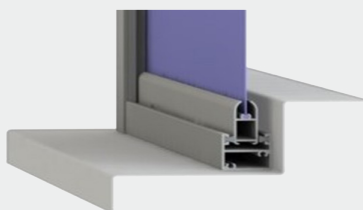

Gravity drop blind optional bottom channel

SHY will choose the most appropriate version for your ZIP® blinds to ensure smooth operation and correct function

OTHER SYSTEMS IN THE ZIP® GRAVITY DROP RANGE

- SHY ZIP® 65 gravity drop system
- SHY ZIP® 200 Plus gravity drop system

GET IN TOUCH...

UK T: 01462 455 400
 Worldwide T: +44 1462 455 400
 Email: info@shy.co.uk

Head Office
 2B Dunhams Lane,
 Letchworth, Herts, SG6 1BE

www.shy.co.uk